

---

## Conversion of Dilute Pump Blood to Whole Blood by Single Pass Ultrafiltration

---

**Yehuda Tamari, Roy Nelson, Ronald Levy, Nancy Rea, Michelle Salogub, Clifford Carolina, Michael Hall, Carmine Moccio, and Anthony Tortolani**

Division of Cardiovascular Surgery  
Department of Surgery  
North Shore University Hospital  
Manhasset, New York  
and  
Department of Surgery  
Cornell University Medical College  
New York

### Abstract

Ultrafiltration (UF) effectively reverses hemodilution. However, when used to concentrate pump blood post-bypass, the recirculation method does not make concentrated blood available until all the blood has been processed. To make concentrated whole blood immediately available, we have investigated the use of a single pass ultrafiltration (SPUF) technique in 7 patients. By reducing the blood flow, the concentration of the blood components at the outlet of the ultrafilter (UF) was sufficient to allow direct transfusion. After bypass, the blood in the oxygenator ( $1664 \pm 112$  ml) was pumped ( $153 \pm 12$  ml/min) through an UF device and into a transfusion bag. Suction ( $-480$  torr) applied to the device extracted plasma water ( $82 \pm 3$  ml/min). SPUF concentrated the diluted pump blood as follows (mean  $\pm$  standard error of the means): WBC from  $8.5 \pm 1.2$  to  $16.3 \pm 2.5 \times 10^3$ /ul, hemoglobin ( $6.5 \pm 0.2$  to  $13.2 \pm 0.5$  gr/dl), platelets ( $135 \pm 14$  to  $224 \pm 32 \times 10^3$ /ul), albumin ( $2.9 \pm 0.2$  to  $7.6 \pm 0.6$  gr/dl) and fibrinogen ( $114 \pm 9$  to  $274 \pm 26$  mg/dl). For heparin neutralized plasma, there was a decrease towards normal in prothrombin time ( $17.9 \pm 0.6$  to

$14.1 \pm 0.3$  sec) and activated partial thromboplastin time ( $46 \pm 2$  to  $32 \pm 2$  sec). There was no net increase in plasma free hemoglobin. Red cell indices tended to normalize. Following transfusion of the concentrated blood there were increases in albumin ( $3.4 \pm 0.2$  to  $3.9 \pm 0.2$  gr/dl) and hemoglobin ( $8.5 \pm 0.6$  to  $9.5 \pm 0.6$  gr/dl). There were no statistically significant changes in white blood cells, platelets, prothrombin and activated partial thromboplastin time. Conclusion: SPUF is an efficient, useful, safe, simple and rapid method for obtaining whole blood for immediate transfusion.

### Introduction

Ultrafiltration has been shown to be useful in controlling hemodilution during cardiopulmonary bypass (CPB) especially for patients with poor kidney function and/or when large volumes of crystalloid cardioplegia solution are administered.<sup>1,2,3</sup> After bypass, ultrafiltration can be used to concentrate the dilute blood remaining in the extracorporeal circuit thus making whole autologous blood available for transfusion.<sup>4,5,6,7</sup>

The usual method of hemoconcentration after bypass is to recirculate the blood from the oxygenator through the ultrafilter (UF), where plasma water is extracted, and then back to the oxygenator. Recirculation is continued until all the blood in the oxygenator has been concentrated. The blood is then collected into a transfer bag and

---

This work was supported in part by NIH Grant # S08-RR-09128-03 and by a Grant-in-Aid from the American Heart Association, Nassau and Suffolk County Chapters.

Direct communications to: Yehuda Tamari, Division of Cardiovascular Surgery, North Shore University Hospital, Manhasset, NY 11030.

Presented at AmSECT's 21st International Conference, New Orleans, LA, April 10-13, 1983.

made available for transfusion. The concentration of all the blood requires 10–30 minutes depending on the type of UF used and the volume of blood to be concentrated. With this method, no blood is available for transfusion until *all* of the volume in the oxygenator has been concentrated.

In order to make concentrated blood immediately available, we evaluated the conversion of dilute blood to whole blood by single pass ultrafiltration (SPUF). With this method blood is drawn from the oxygenator and pumped through the UF device at a low flow rate such that a sufficient volume of plasma water is extracted to obtain whole, non-diluted blood at the outlet of the UF. In this manner concentrated blood is available for immediate transfusion. It is the purpose of this paper to describe the governing principles and equations determining the flow conditions required for a single pass system and to summarize the clinical data obtained with this method.

### Theoretical and Clinical Considerations

For SPUF, it is necessary to establish the relationship between the concentration at the outlet of the UF and the blood flow entering the UF. For blood components that do not cross the UF membrane, the total amount of component entering the UF should equal the total amount leaving (Fig. 1)

$$C_i Q_i = C_o Q_o \quad \text{Eq. 1}$$

where  $C_i$  and  $C_o$  are the inlet and outlet concentration of the component of interest and  $Q_i$  and  $Q_o$

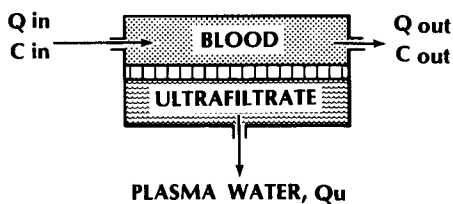

$$\begin{aligned} \text{TOTAL FLOW IN} &= \text{TOTAL FLOW OUT} \\ Q_{in} &= Q_{out} + Q_u \end{aligned}$$

TOTAL COMPONENTS IN = TOTAL COMPONENTS OUT

$$C_{in} \times Q_{in} = C_{out} \times Q_{out}$$

$$C_{out}/C_{in} = 1/(1 - Q_u/Q_{in})$$

FIGURE 1. Governing Equations for Ultrafiltration.  $Q_{in}$  is the blood flow at the inlet,  $Q_{out}$  is the blood flow at the outlet and  $Q_u$  is the plasma water extraction rate.  $C_{in}$  and  $C_{out}$  are the concentrations, at the inlet and outlet respectively, of components that do not cross the membrane.

are the inlet the outlet blood flow of the UF device respectively.

Also, the total flow entering the UF must equal the total flow exiting. Thus

$$Q_i = Q_o + Q_u \quad \text{Eq. 2}$$

where  $Q_u$  is the ultrafiltration flow or water extraction rate (ml/min).

From equations (1) and (2) it is possible to relate the concentration increase,  $C_o/C_i$ , to the inlet blood flow and water extraction rate,

$$\begin{aligned} C_o/C_i &= \frac{Q_i}{(Q_i - Q_u)} \\ &= \frac{1}{(1 - Q_u/Q_i)} \end{aligned} \quad \text{Eq. 3}$$

$C_o/C_i$ , expressed as percent, will be referred to as the Outlet Concentration Ratio.  $Q_u/Q_i$ , expressed as a fraction, will be referred to as the Extraction Ratio. The relationship between the Outlet Concentration Ratio and Extraction Ratio is shown in Figure 2.

The relationship between the water extraction rate and the inlet blood flow for Bentley's Continuous Blood Processor (CBP-6000) is shown in Figure 3. The data was collected with an inlet he-

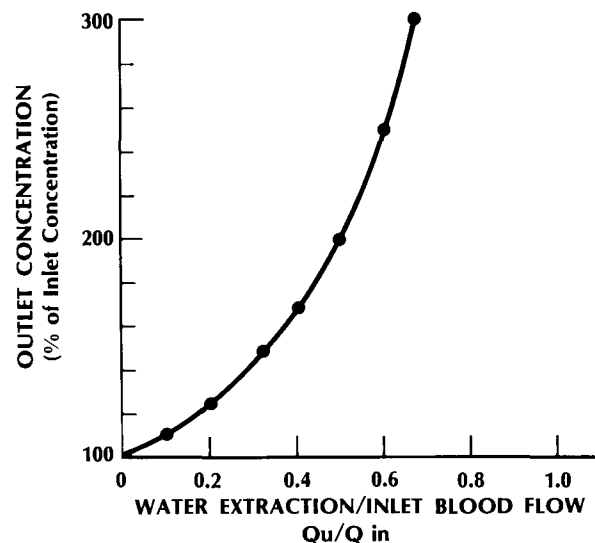

FIGURE 2. Effect of Water Extraction Ratio on Expected Outlet Concentration. This is a graphic representation of Equation #3. As the water extraction ratio increases the outlet concentration of non-diffusible components increases. The outlet concentration increases with either increasing water extraction or decreasing inlet blood flow or both.

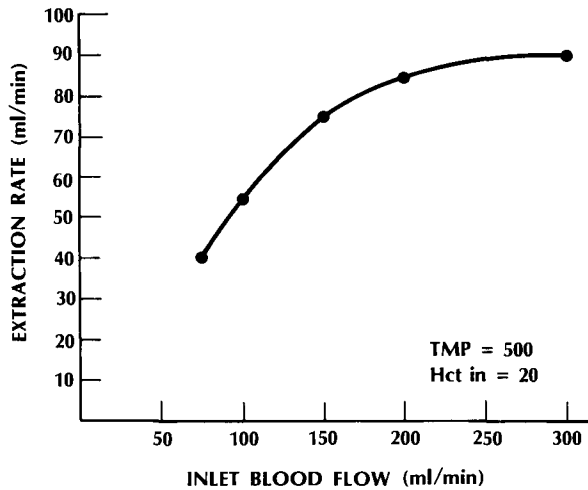

FIGURE 3. Effect of Inlet Blood Flow on Extraction Rate. These results were obtained using a Bentley CBP-6000 ultrafilter at a transmembrane pressure of 500 torr with an inlet hematocrit of 20%. As inlet blood flow decreases the ultrafiltration rate decreases.

matocrit of 20% and a transmembrane pressure of 500 torr. As the blood flow decreases the water extraction rate decreases. The decrease is greater at the lower blood flow. This is a result of an increase in the layer of protein along the filtering membrane. The protein layer, called concentration polarization, decreases the water extraction in two ways: first it causes an additional barrier to water extraction and second it increases the oncotic pressure at the wall which in turn reduces the effective transmembrane pressure<sup>8</sup> (Figure 4). At lower blood flow rates the protein layer thickens as more plasma water is extracted from each milliliter of blood. In addition, the lower blood flow also reduces the shear rate, the rate of change of the velocity at the wall, causing less "washing" away of the protein layer.<sup>8</sup> This is

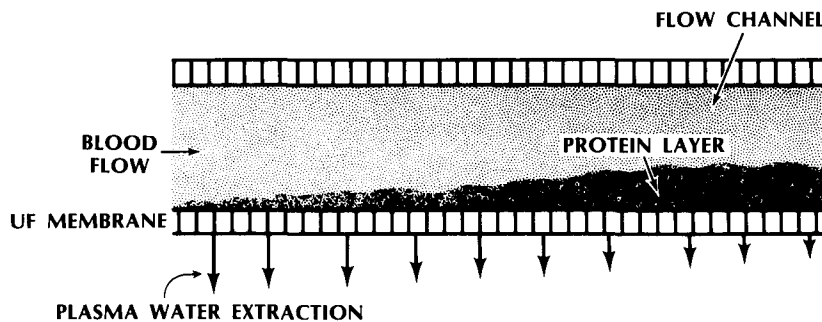

FIGURE 4. Concentration Polarization. As the protein layer increases in thickness (shown exaggerated) the water extraction rate decreases. The layer is greatest at the outlet where the blood flow is lowest.

especially true at the outlet of the UF where the blood flow rate is lowest and protein concentration is highest.

By combining the data from Figure 3 with Equation 3 it is possible to relate the Outlet Concentration Ratio to the inlet blood flow (Figure 5). The Outlet Concentration Ratio obtained for the test conditions given, increases from 140% to 200% as the blood flow decreases from 300 to 150 ml/min. Further decreases in the blood flow do not significantly increase the Outlet Concentration Ratio. Reducing the blood flow below 150 ml/min causes a corresponding decrease in the water extraction rate (Figure 3) such that the ratio of  $Q_u/Q_i$  in Equation 3 changes minimally.

The maximum extraction rate also depends on the initial concentrations of protein and cells. Higher initial concentration of these components can cause lower extraction rates. However, for the dilute blood found in the pump oxygenator with a hematocrit between 15 and 25% and the correspondingly low protein concentration, the extraction rate should not change by more than 10%.<sup>8</sup> The lower rate of water extraction from more concentrated blood is partially self-compensating since less plasma water must be removed to achieve the same outlet concentration.

The optimum flow for any desired Outlet Concentration Ratio can be derived from Figure 5. Clinically, it is desirable to have the highest possible concentration at the outlet. Blood flow may be increased but at the expense of a lower outlet concentration. This requires low blood flow.

Single pass ultrafiltration also makes it possible to transfuse a larger volume to the patient. This is best demonstrated with an example: At the end of bypass 1000 ml of blood with a Hct of 20% are left

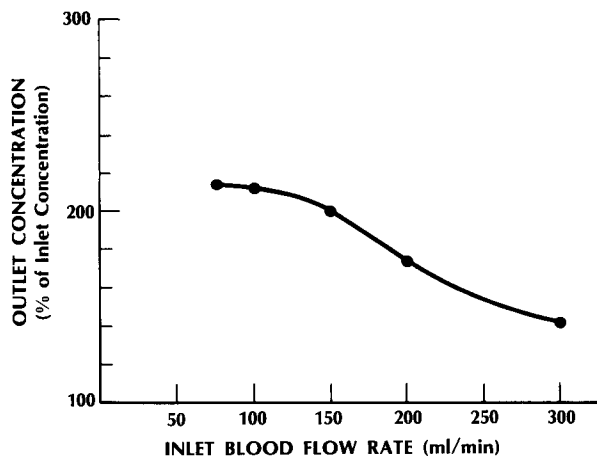

FIGURE 5. Effect of Inlet Blood Flow on Outlet Concentration. The graph was constructed using the data from Figure 3 and applying equation 3. Reducing inlet blood flow increases outlet concentration. However the increases in outlet concentration plateaus at blood flow below 150 ml/min.

in the oxygenator but 300 ml must remain in case the patient needs to go back on bypass. Using recirculation, to transfuse blood with a Hct of 40%, 500 ml of plasma water must be extracted. This produces 200 ml of blood for transfusion (1000 ml initial blood volume – 500 ml water extracted – 300 ml required oxygenator blood level). With single pass it is possible to transfuse 350 ml of blood with Hct of 40% (1000 ml initial blood volume – 300 ml required oxygenator volume = 700 ml). When the 700 ml of blood are concentrated to a Hct of 40% by single pass ultrafiltration, the resulting volume is 350 ml. The additional volume available with the single pass technique results from leaving dilute blood in the oxygenator. With recirculation, the 300 ml in the oxygenator is concentrated blood.

## Clinical Evaluation

### Method

Single pass ultrafiltration was studied in 7 patients undergoing coronary bypass surgery using the cardiopulmonary bypass circuit and prime previously described.<sup>5</sup> A CBP-6000<sup>a</sup> UF unit was flushed and primed by a single pass of 1000 ml of plasmalyte.<sup>b</sup> A calibrated roller pump<sup>c</sup> was used to pump blood from the coronary port of the

H1000A Harvey oxygenator<sup>d</sup> through the UF. A Y-connector was placed in the blood outlet port of the UF with one arm connected to the luer fitting of the oxygenator and the other arm connected to a transfer bag (Figure 6). When bypass was terminated, a blood sample, pre-concentration (Pre-Conc), was taken from the oxygenator. The blood volume was then recorded and the blood pumped at 160 ml/min through the UF. The UF outlet connection to the oxygenator was clamped off, the crystalloid prime was allowed to flow to the transfer bag, and suction (–480 torr) was applied to the UF. The crystalloid prime was collected via the open patient port of the transfer bag and then discarded. When the blood cleared the priming solution and appeared in the outlet, the patient port was closed and the concentrated blood was collected. For this study the processed blood was not administered to the patient until it was all collected. If the patient was unstable, the blood level in the oxygenator was not allowed to go below 200 ml. When that level was reached ultrafiltration was stopped, the recirculation line (B in Figure 6) was unclamped, the one pass line (A in Figure 6) was clamped and the vacuum was removed. This maneuver assured blood flow through the UF at all times even when no blood was ultrafiltered. After all the blood was processed a blood sample was taken from the bag (post-concentration, Post-Conc) and from the patient (Patient Control). The processed blood was then transfused to the patient. Protamine, calculated from the transfused blood volume and its heparin level was given. Thirty minutes after the blood was transfused, another blood sample was taken from the patient (Post-Transfusion).

To evaluate the effect of the ultrafiltration on individual blood component levels the following four groups of tests as previously described<sup>5</sup> were performed on the blood samples. Group 1 (small molecules): glucose, choride, potassium, sodium and calcium; Group 2: albumin, lactate dehydrogenase (LDH) and creatinine phosphokinase (CPK); Group 3 (Hematological values): white blood cells (WBC), red blood cells (RBC), hemoglobin (Hgb), mean corpuscular volume (MCV), mean corpuscular hemoglobin (MCH), mean corpuscular hemoglobin concentration (MCHC),

<sup>a</sup> American Bently, Irvine, CA 92714.

<sup>b</sup> Travenol Laboratories, Deerfield, IL 60015.

<sup>c</sup> American Optical, Picker International, Ossining, NY 16562.

<sup>d</sup> Bard Cardiopulmonary, Santa Ana, CA 92705.

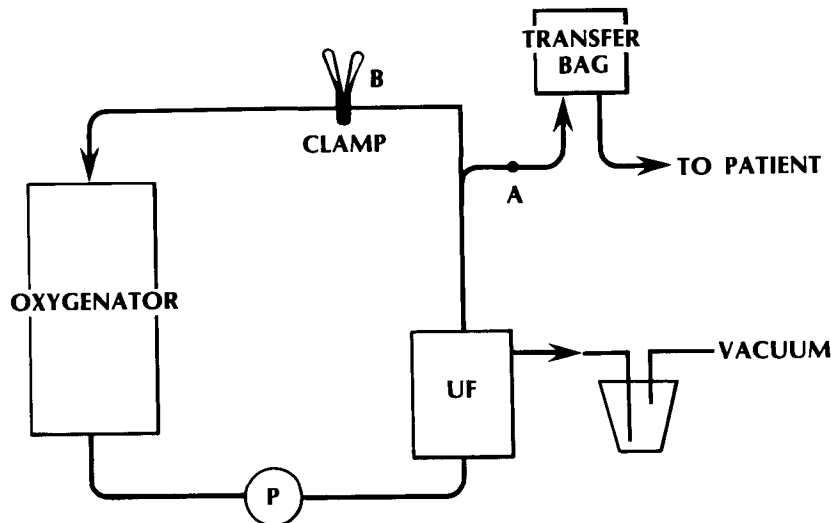

FIGURE 6. Single Pass Ultrafiltration Circuit. A Clamp was applied at B. For recirculation with or without plasma water extraction the clamp was moved from B to A. During single pass ultrafiltration the blood can be either collected in the transfer bag or flow through the bag and be given directly to the patient.

platelet count and plasma Hgb; Group 4, coagulation profile: prothrombin time (PT), activated partial thromboplastin time (APTT), thrombin time (TT), fibrinogen and whole blood heparin concentration.

The data was analyzed in two ways. First, the pre to post concentration values were compared. Second, the percent increase in each of the components, the Measured Outlet Concentration ratio, was compared to the percent increase in total hemoglobin. Hemoglobin was chosen as a marker for comparison because it does not cross the filtering membrane and is not affected by the process. A component having a Measured Outlet Concentration ratio lower than that for hemoglobin, indicates loss of component by the process.<sup>5</sup> Similarly, a component with a Measured Outlet Concentration ratio greater than that for hemoglobin indicated a gain of that component. The Measured Outlet Concentration ratio of total hemoglobin was also compared to the Expected Outlet Concentration ratio, calculated from Equation 3.

Since the Measured Outlet Concentration ratio for each component was calculated from the blood concentration, the values for components measured in plasma had to be converted to concentrations in blood.<sup>5</sup> This was done as follows:

$$C(\text{blood}) = 100 \times C(\text{plasma}) \times (100 - \text{Hct})$$

All comparisons were made using a paired t-test and all results are given as mean  $\pm$  standard error

of the mean. Unless otherwise noted, all differences are statistically significant, ( $P < 0.05$ ).

## Results

The volume left in the oxygenator was  $1664 \pm 112$  ml and the volume of the blood collected was  $798 \pm 48$  ml resulting in an Expected Outlet Concentration ratio of  $202 \pm 8\%$ . The transmembrane pressure was  $499 \pm 9$  mm Hg and the plasma water extraction rate was  $82 \pm 3$  ml/min.

The data obtained are summarized in Table 1. Ultrafiltration of the dilute pump blood increased the concentration of albumin (from  $2.9 \pm 0.2$  to  $7.6 \pm 0.6$  gr/dl), LDH ( $392 \pm 41$  to  $1016 \pm 89$  u/L), CPK ( $281 \pm 54$  to  $635 \pm 110$  u/L), WBC ( $8.5 \pm 1.2$  to  $16.3 \pm 2.5 \times 10^3/\text{ul}$ ), RBC ( $2.00 \pm 0.08$  to  $4.12 \pm 0.17 \times 10^6/\text{ul}$ ), Hgb ( $6.5 \pm 0.2$  to  $13.2 \pm 0.5$  gr/dl), platelets ( $135 \pm 14$  to  $224 \pm 32 \times 10^3/\text{ul}$ ), plasma Hgb ( $144 \pm 23$  to  $362 \pm 55$  mg/dl) and fibrinogen ( $114 \pm 9$  to  $274 \pm 26$  mg/dl). Following ultrafiltration MCH decreased toward normal from  $32.9 \pm 0.4$  to  $32.0 \pm 0.4$  ug.

There were decreases in the concentration of glucose and chloride, a very small increase in sodium, a 35% increase in calcium and no changes in potassium. The final concentrations of these components were all within normal physiological ranges. The abnormally high PT, APTT and thrombin times obtained for the dilute pump blood decreased to normal following concentration. The

TABLE 1

	Units	Pre Conc		Post Conc		% Post/Pre *		P < Post vs Pre
		MEAN	SEM	MEAN	SEM	MEAN	SEM	
Glucose	mg%	171.0	15.00	141.00	15.00	62.0	2.0	.0005
Chlorine	mEq/L	105.0	2.00	95.00	3.00	68.0	2.0	.0005
Potassium	mEq/L	4.8	0.30	4.70	0.30	74.0	4.0	NS
Sodium	mEq/L	139.9	1.20	142.00	0.90	77.0	1.0	.0150
Calcium	mg%	8.5	1.00	11.50	0.50	107.0	6.0	.0040
Albumin	gm%	2.9	0.20	7.60	0.60	194.0	11.0	.0005
LDH	u/L	392.0	41.00	1016.00	89.00	203.0	17.0	.0005
CPK	u/L	281.0	54.00	635.00	110.00	179.0	14.0	.0020
WBC	X10 <sup>3</sup> /ul	8.5	1.20	16.30	2.50	191.0	7.0	.0010
RBC	X10 <sup>6</sup> /ul	2.0	0.08	4.12	0.17	208.0	9.0	.0005
HGB	gr%	6.5	0.20	13.20	0.50	202.0	9.0	.0005
MCV	um <sup>3</sup>	91.7	1.10	92.10	1.30	100.0	0.5	NS
MCH	μug	32.9	0.40	32.00	0.40	97.0	0.5	.0010
MCHC	%	35.9	0.30	34.30	0.60	95.60	1.6	.0230
Platelet	X10 <sup>3</sup> /ul	135.0	14.00	224.00	32.00	166.0	15.0	.0060
PI Hgb	mg%	144.0	23.00	362.00	55.00	210.0	38.0	.0030
PT	sec	17.9	0.60	14.10	0.30	—	—	.0005
APTT	sec	46.0	2.00	32.00	2.00	—	—	.0005
TT	sec	6.2	0.90	3.40	0.40	—	—	NS
Fibrinogen	mg%	114.0	9.00	274.00	26.00	181.0	8.0	.0005
Heparin	u/ml	4.0	0.20	4.10	0.20	102.0	6.0	NS

All values are means ± standard error of the mean. P values > 0.05 by paired t-test was considered non-significant (NS). Abbreviations: Conc, concentration; u, units; L, liter; LDH, lactic dehydrogenase; CPK, creatinine phosphokinase; WBC, white blood cell; RBC, red blood cell; Hgb, hemoglobin; MCV, mean corpuscular volume; MCH, mean corpuscular hemoglobin; MCHC, mean corpuscular hemoglobin concentration; PI, plasma; PT, prothrombin time; APTT, activated partial thromboplastin time; TT, thrombin time; sec, seconds.

\* Whole blood concentrations were used for calculations.

whole blood heparin concentration remained constant.

A comparison of the data obtained from the blood samples taken before and after the transfusion of the concentrated blood showed that there were statistically significant increases in albumin (from 3.4 ± 0.2 to 3.9 ± 0.2 gr/dl), LDH (334 ± 54 to 417 ± 49 u/L), CPK (237 ± 29 to 324 ± 54 u/L), WBC (11.2 ± 1.1 to 12.4 ± 1.4 × 10<sup>3</sup>/ul), RBC (2.65 ± 0.20 to 2.94 ± 0.19 × 10<sup>6</sup>/ul), Hgb(8.5 ± 0.6 to 9.5 ± 0.6 gr/dl) and plasma hemoglobin (61 ± 21 to 82 ± 25 mg/dl). There was a decrease in thrombin time towards normal (5.0 ± 0.3 to 4.2 ± 0.4 sec).

## Discussion

With an inlet blood flow rate of 160 ml/min and a hematocrit of 20% it was possible to extract 82 ml/min of plasma water, producing an Extraction Ratio of 0.51. This Extraction Ratio produced an Expected Outlet Concentration Ratio of 202% (Equation 3). That is, the Expected Outlet Con-

centration of any blood component that does not cross the UF membrane should be 202% of the inlet concentration. A comparison between the Expected Outlet Concentration ratio and Measured Outlet Concentration ratio is given in Figure 7. There were no differences between the Measured Outlet Concentration ratio for hemoglobin and that for albumin, LDH and plasma Hgb. Also, the Measured Outlet Concentration ratio for Hgb was not different from the Expected Outlet Concentration ratio. This indicates that the single pass ultrafiltration does not cause a loss of Hgb or albumin, nor a gain of LDH or plasma Hgb. The lower Measured Outlet Concentration ratios for WBC, platelets, and fibrinogen indicate some losses (5%, 20%, and 10% respectively) in these components. The heparin loss was 50%. The net decreases in the small molecules, except calcium correspond to the volume of ultrafiltrate. Thus, the results with the single pass method are similar to those obtained for ultrafiltration using the recirculation technique.<sup>6</sup> The beneficial effects of transfusing the concentrated blood were seen in

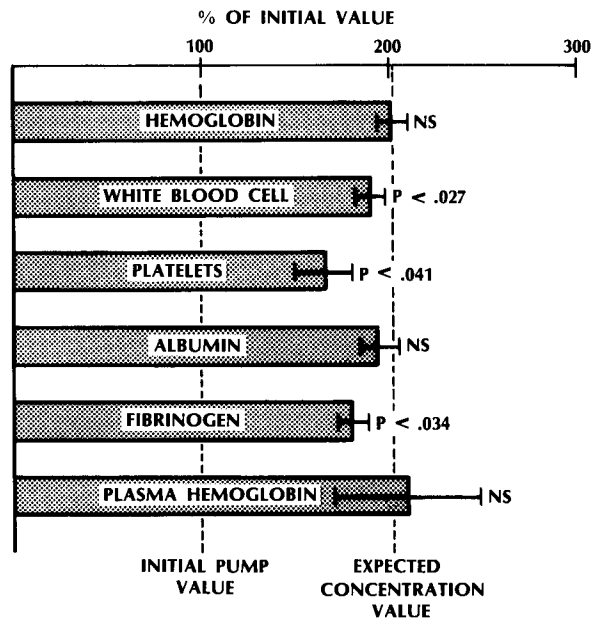

FIGURE 7. Comparison between the Expected Concentration and the Measured Outlet Concentration. The data is expressed in terms of the initial (pre-concentration) levels. Single pass ultrafiltration conserved the hemoglobin and albumin without production of plasma hemoglobin. Small losses in platelets, white blood cells and fibrinogen are seen.

the increases in the patient's albumin, WBC, RBC and Hgb. Some of the changes may have been due to diuresis and fluid shifts. The increase in the plasma hemoglobin to 82 mg/dl following transfusion was significantly lower than the 144 mg/dl level seen immediately post-bypass.

The maximum concentration that can be achieved at the outlet of the UF with SPUF is limited by concentration polarization. If ultrafiltration cannot bring the final concentration to the desired level in a single pass, then a short recirculation period can be used to raise the initial concentration level. The higher initial concentration would then allow the use of single pass technique

to reach the desired final concentration. With very dilute blood, the combination of recirculation followed by single pass ultrafiltration can provide the desired final concentration in the shortest possible time.

The data described was obtained for single pass ultrafiltration using a specific parallel plate ultrafiltration device. The use of other devices requires similar evaluations.

## Conclusion

Conversion of dilute blood to whole blood by single pass ultrafiltration has been shown to be a simple procedure which can provide whole autologous blood to the open heart surgical patient with the advantage of providing concentrated blood for immediate transfusion and a greater recovery of whole blood.

## References

1. Hopeck, J. M. Lane, R. S., and Schroeder, J. W.: Oxygenator volume control by parallel ultrafiltration to remove plasma water. *J.E.C.T.* 13:267-271, 1981.
2. Darup, J., Blese, N., Kalmar, P., Outz, G., Pokar, H., and Polonius, M.J.: Hemofiltration during extracorporeal circulation (EEC). *Thorac. Cardiovasc. Surgeon.* 27:227-230, 1979.
3. Magilligan, D. J., Jr. and Oyama, C.: Ultrafiltration to decrease the accumulation of lung water during cardiopulmonary bypass. *Surgical Forum.* 33:256-257, 1982.
4. Romagnoli, A; Hacker, J., Keats, A. D. and Milam, J.: External hemoconcentration after deliberate hemodilution. (Abst) Am. Soc. Anesth. 1976, Annual Meeting.
5. Tamari, Y., Nelson, R., Levy, R., Carolina, C., Salogub, M., Rea, N., Hall, M., Moccio, C., and Tortolani, A.: Concentration of blood in the extracorporeal circuit using ultrafiltration. *J.E.C.T.* 15:133-140, 1983.
6. Tamari, Y., Nelson, R., Levy, R., Salogub, M., Rea, N., Carolina, C., Moccio, C., Hall, M. and Tortolani, A.: Effects of the Hemo-Concentrator on blood. Presented at 21st International Am Soc Extra-Corp Tech Meeting, New Orleans, LA 1983.
7. Brickley, J. M., Kalshoven, J. D., Wilds, S. L. and Dearing, J. P.: A comparison of two methods of post-bypass hemoconcentration. *J.E.C.T.* 14:431-436, 1982.
8. Colton, C. K., Henderson, L. W., Ford, C. A., Lysaght, M. J.: Kinetics of hemofiltration I. In-vitro transport characteristics of hollow-fiber blood ultrafilter. *J. Lab. Clin. Med.* 85:355-371, 1975.