

## Original Article

# *Predicting Oxygenator Clinical Performance from Laboratory In-Vitro Testing*

Kevin E. Griffith, BS, Marco R. Vasquez, BS, Philip D. Beckley, PhD, \*Brian J. LaLone, PhD, CCP

Division of Circulation Technology, School of Allied Medical Professions  
The Ohio State University, Columbus, Ohio

\*Indiana University Hospitals  
Indianapolis, Indiana

Presented at the 32nd Annual International Conference of the American Society of Extra-Corporeal Technology, Anaheim, California, April 8-11, 1994

Keywords: evaluation, membrane oxygenator; gas transfer, carbon dioxide; gas transfer, oxygen; heat exchange efficiency; pressure drop

### ABSTRACT

Knowledge and predictability of oxygenator performance is vital to safe and effective conduct of cardiopulmonary bypass. The determination of oxygenator performance in the laboratory, however, is carried out under a strict set of conditions established by the Association for the Advancement of Medical Instrumentation (AAMI). This performance data is of limited value in the clinical setting where the perfusionist generally operates outside this set of parameters. This study (1) reports the laboratory performance characteristics of a hollow fiber membrane oxygenator (Sorin Monolyth), (2) uses this data to develop a model to predict performance under a wide range of clinical conditions, (3) compares predicted performance with clinical data collected at two open heart centers, and (4) reviews the complexities of comparing laboratory and clinical performance.

An in-vitro "oxygenator-deoxygenator" circuit was utilized to determine O<sub>2</sub> and CO<sub>2</sub> gas exchange, blood path pressure drop, and heat exchanger efficiency at a variety of blood and gas flows, under standard (AAMI) blood inlet conditions:

BF	O <sub>2</sub> (a)	O <sub>2</sub> (b)	O <sub>2</sub> (c)	CO <sub>2</sub> (a)	CO <sub>2</sub> (b)	CO <sub>2</sub> (c)	PD	Che
3.0	210±7	196±8	177±6	109±4	186±8	237±8	29±8	0.67±0.03
4.0	264±13	241±18	226±10	147±8	246±13	300±17	44±10	0.59±0.04
5.0	326±15	307±10	272±7	174±4	285±7	356±7	48±10	0.55±0.02

where BF = blood flow rate (L/min); O<sub>2</sub>(a) = O<sub>2</sub> transfer at FiO<sub>2</sub> 1.0 and Qg:Qb 1.0; O<sub>2</sub>(b) = O<sub>2</sub> transfer at FiO<sub>2</sub> 0.8 and Qg:Qb 1.0; O<sub>2</sub>(c) = O<sub>2</sub> transfer at FiO<sub>2</sub> 0.6 and Qg:Qb 1.0; CO<sub>2</sub>(a) = CO<sub>2</sub> transfer at FiO<sub>2</sub> 1.0 and Qg:Qb 0.5; CO<sub>2</sub>(b) = CO<sub>2</sub> transfer at Qg:Qb 1.0 and FiO<sub>2</sub> 1.0; CO<sub>2</sub>(c) = CO<sub>2</sub> transfer at FiO<sub>2</sub> 1.0 and Qg:Qb 1.5 (all transfer values in ml/min); PD = blood path pressure drop (mmHg); Che = warming coefficient of heat exchange; values expressed as mean ± 1 SD

This laboratory performance data was compared to hospital and computer modeling data. Simple numerical comparison and analysis of variance of regression coefficients over groups indicated that some clinical parameters of performance (oxygen transfer and coefficient of heat exchange) were not predicted with the laboratory data. It is concluded that the laboratory performance data determined under strict controlled conditions may be of limited value in predicting clinical performance unless modeled to allow for variances in operating conditions.

## INTRODUCTION

Safe and effective conduct of cardiopulmonary bypass (CPB) is dependent on the perfusionist's knowledge of oxygenator function and the assumption that oxygenator performance is consistent and predictable. Performance data reported by manufacturers is usually obtained from laboratory testing, during which variables affecting resistance to blood flow, heat exchange, and gas transfer can be closely controlled. The Association for the Advancement of Medical Instrumentation (AAMI) has established a strict set of testing conditions which has standardized testing and makes comparison of results possible (1). However, patients presenting for heart surgery rarely conform to this set of standard conditions. This makes it difficult for the perfusionist to predict oxygenator performance when used clinically and can result in less than optimal patient outcome.

In-vitro laboratory testing procedures for the hollow fiber membrane oxygenator (HFMO) have been well described by several investigators (2,3). Application of these testing procedures to clinical studies has also been reported (4-7). Many of these investigators have suggested that testing data may not be entirely accurate as a means of predicting clinical performance.

The purpose of this study was to characterize the performance of the Sorin Monolyth HFMO using a protocol that included the AAMI standards for control of venous blood inlet conditions to the oxygenator. Clinical data gathered at two medical centers was then compared to the laboratory performance data with the aid of computer modeling and statistical techniques.

## MATERIALS AND METHODS

The Sorin Monolyth<sup>a</sup> is a member of the new generation of HFMOs featuring the blood flow path outside the gas carrying fibers. The polypropylene hollow fibers of the Monolyth are woven into a mat design and have an outer diameter of 380 microns, a wall thickness of 50 microns, and a porosity of 50% with a micropore size of 700 angstroms (manufacturer's data supplied by Sorin Biomedical, Irvine, CA). The device has an effective surface area of 2.2 m<sup>2</sup>. Venous blood enters the oxygenator module at the lower part of a pleated and grooved epoxy coated stainless steel heat exchanger which has a 0.17 m<sup>2</sup> surface area. Water flows through the heat exchanger in countercurrent fashion with the blood flow. Blood flows upward through the heat exchanger where it then enters the top of the gas exchange section of the module. An air purging system utilizing one-way

"umbrella" valves is located at this uppermost point of blood flow. The blood then flows around and outside of the membrane fibers in a downward cross flow pattern, exiting at the bottom of the device. Ventilating gas enters the device at the top of the membrane section and flows internally through the hollow fibers and exits at the bottom through a collecting cap gas outlet. The Monolyth housing is constructed of polycarbonate. The device has a rated blood flow of 1-8 L/min, a maximum gas flow of 15 L/min, a total priming volume of 300 ml, and maximum blood and water pressure limits of 1 and 2 ATM respectively.

## THE TEST CIRCUIT

The Monolyth was tested using an in-vitro oxygenator-deoxygenator single pass circuit as shown in Figure 1 which was patterned after the design of others (3). The circuit consisted of three interconnected flow paths used in concert at various points in the protocol. A venous conditioning flow path was used to establish the standard inlet conditions of the venous blood prior to entry into the test oxygenator. Inlet conditions achieved were those established by AAMI for standardized testing: oxyhemoglobin saturation = 65±5%, hemoglobin content = 12±1 gm%, pCO<sub>2</sub> = 45±5 mmHg, and base excess = 0±5 meq/L. The recirculation flow path was used to keep blood flow moving through the test oxygenator at 2 L/min (with gas to blood flow ratio at 1.0 and FiO<sub>2</sub> at 1.0) while venous inlet conditions were being established. An arterial flow path was used to move the conditioned venous blood into the test oxygenator at pre-selected blood flow rates. These blood flow paths were all constructed with 3/8" x 3/16" polyvinyl chloride tubing.

Two roller pumps<sup>b</sup> were used to pump through the flow paths of the test circuit. A third roller pump was used to constantly recirculate and mix the venous conditioned blood. Two oxygenator modules<sup>c</sup> were used as deoxygenators to establish the venous blood conditions. Large 20 liter polycarbonate containers were used to hold the conditioned blood and receive the oxygenated blood pumped through the Monolyth oxygenator being evaluated. Specific gas mixtures were delivered into the deoxygenators and test oxygenator from an anesthesia gas blending manifold<sup>d</sup> and gas blender<sup>e</sup> respectively. Monitoring of blood conditions

- 
- a Sorin Biomedical, Irvine, CA 92714
  - b Model 10-00-00, Stockert-Shiley, Sorin Biomedical, Irvine, CA 92714
  - c Model 9443, Sarns/3M, Ann Arbor, MI 43103
  - d Foregger, Smithtown, NY 11787
  - e Sechrist Industries, Anaheim, CA 92802

---

Address Correspondence to:  
Philip D. Beckley, PhD  
Division of Circulation Technology, School of Allied Medical Professions  
The Ohio State University  
1583 Perry Street  
Columbus, Ohio 43210

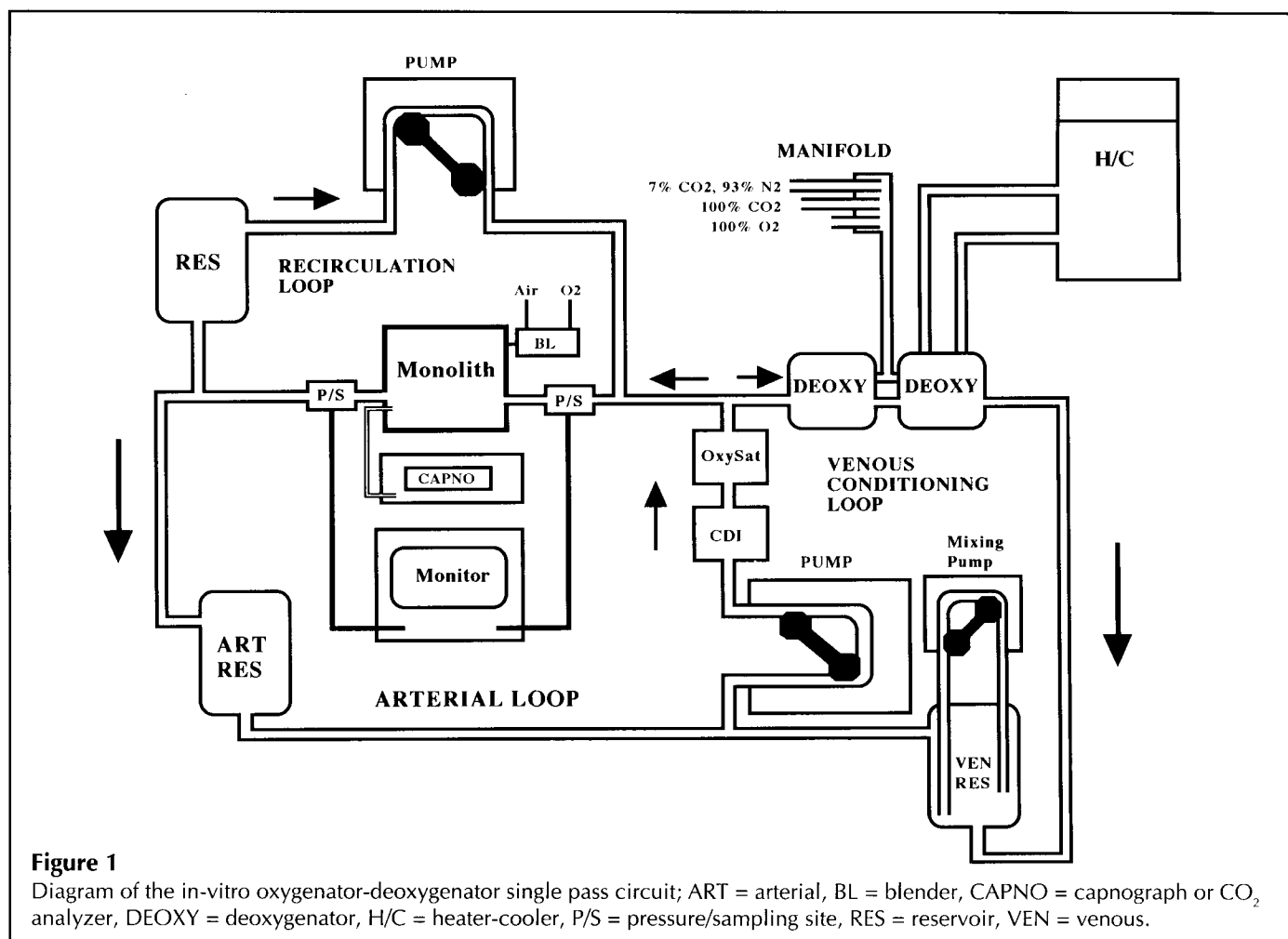

was accomplished with the in-line monitor<sup>f</sup> and a hemoglobin oxygen saturation meter<sup>g</sup>. The inlet and outlet pressures of the blood path of the Monolith were monitored with appropriately calibrated transducers<sup>h</sup> connected to a pressure monitor<sup>i</sup>. Percent carbon dioxide in the outlet gas from the Monolith was determined with an appropriately calibrated CO<sub>2</sub> analyzer<sup>j</sup>. The blood was maintained at  $37 \pm 2^\circ\text{C}$  throughout the experiment (AAMI standard) by supplying water to the Monolith and deoxygenator

heat exchangers from a heater-cooler<sup>k</sup>. Blood temperature was monitored with probes attached to a temperature meter<sup>l</sup>. Water inlet temperature to the heat exchanger was similarly monitored. All probes were checked for accuracy against a mercury thermometer and were found to be within  $0.2^\circ\text{C}$  of the standard.

#### EVALUATION PROTOCOL

The arterial blood flow path contained the test oxygenator. Blood flows ( $Q_b$ ) of 2.0, 3.0, 4.0, 5.0, and 6.0,  $\text{FiO}_2$  values of 1.0, 0.8, and 0.6, and gas to blood flow ratios ( $Q_g:Q_b$ ) of 0.5, 1.0, and 1.5 were chosen as test variables. Oxygen transfer was determined at all blood flows and  $\text{FiO}_2$  values with  $Q_g:Q_b$  held constant at 1.0. Carbon dioxide transfer was determined at all blood flows and  $Q_g:Q_b$  values with  $\text{FiO}_2$  held constant at 1.0. Combinations of variables were randomly chosen prior to each test. Six Monolith oxygenators were tested.

Approximately 18 liters of filtered, citrated, and heparinized bovine blood was added to the primed and debubbled test circuit. Additional Plasmalyte-A<sup>m</sup> was added as needed to achieve a standard hemoglobin content of  $12 \pm 1$  gm%. Hemoglobin content was verified with a co-oximeter<sup>n</sup>. Initial venous condi-

- f Model 400, CDI/3M Health Care, Irvine, CA 92714  
g Model SM-0100, Baxter-Bentley Laboratories, Irvine, CA 92713  
h Model T4812DT-R, Spectramed, Oxnard, CA 93030  
i Model M1094A, Hewlett Packard, Waltham, MA 02254  
j Model LB-2, Beckman Instruments, Fullerton, CA 92634  
k Model 11160, Sarns/3M, Ann Arbor, MI 43103  
l Model 21-01-00, Stockert-Shiley, Sorin Biomedical, Irvine, CA 92714  
m Baxter Healthcare Corp., Deerfield, IL 60015  
n Model OSM3, Radiometer America, Westlake, OH 44145

tioning was accomplished by ventilating the deoxygenators with 7% CO<sub>2</sub> balance N<sub>2</sub> at 10 L/min with the venous flow path pump set at 4 L/min. When the hemoglobin saturation approached 65%, the ventilating gases were turned off and the blood recirculated for 5 minutes to allow thorough mixing. Small amounts of 100% CO<sub>2</sub> and/or 100% O<sub>2</sub> were used to make final adjustments. Blood samples were analyzed by a blood gas machine<sup>o</sup> and the co-oximeter to confirm the standard venous conditions.

Once the AAMI standards were verified, the conditioned blood was pumped through the Monolith at the predetermined combination of test variables (Q<sub>b</sub>, FiO<sub>2</sub>, and Q<sub>g</sub>:Q<sub>b</sub>). When the CO<sub>2</sub> analyzer reading stabilized, blood samples were drawn from the venous inlet and arterial outlet of the test oxygenator. Exhaust gas % CO<sub>2</sub> and gas flow rate were carefully noted. The blood samples were immediately analyzed for hemoglobin content, arterial and venous hemoglobin saturation, and arterial and venous pO<sub>2</sub>. This data was used to calculate oxygen transfer as follows:

$$O_2 \text{ transfer (ml/min)} = \{[(SaO_2 - SvO_2) \times hgb \times 1.34] + [(paO_2 - pvO_2) \times 0.003]\} \times Q_b \times 10$$

where SaO<sub>2</sub> = arterial hemoglobin saturation (decimal form)  
 SvO<sub>2</sub> = venous hemoglobin saturation (decimal form)  
 hgb = hemoglobin content (gm/dL)  
 1.34 = ml O<sub>2</sub> per gm hgb  
 paO<sub>2</sub> = arterial partial pressure of oxygen (mmHg)  
 pvO<sub>2</sub> = venous partial pressure of oxygen (mmHg)  
 0.003 = ml O<sub>2</sub>/dL per mmHg pO<sub>2</sub>  
 Q<sub>b</sub> = blood flow rate (L/min)  
 10 = conversion factor to change ml O<sub>2</sub>/dL to ml O<sub>2</sub>/L

The exhaust gas % CO<sub>2</sub> and gas flow rate were used to calculate carbon dioxide transfer as follows:

$$CO_2 \text{ transfer (ml/min)} = (Q_g \times 1000) \times \% CO_2$$

where Q<sub>g</sub> = gas flow rate (L/min)  
 % CO<sub>2</sub> = exhaust % CO<sub>2</sub> (decimal form)

This procedure was repeated until the supply of venous conditioned blood was exhausted. At that point, reconditioning to standard conditions was repeated and testing at a new set of variables accomplished.

While performing gas exchange evaluation at each flow, inlet and outlet blood path pressure data were recorded. Resistance to blood flow was calculated as a pressure drop with the following:

$$PD = P_i - P_o$$

where PD = pressure drop (mmHg)

<sup>o</sup> Model AL2RA, Radiometer America, Westlake, OH, 44145

P<sub>i</sub> = inlet pressure (mmHg)  
 P<sub>o</sub> = outlet pressure (mmHg)

At the conclusion of the gas transfer evaluation, the blood was cooled to 28°C. With the heater-cooler set at 38°C, temperatures at the blood inlet, blood outlet, and water inlet were recorded for each flow (2.0, 3.0, 4.0, 5.0, and 6.0 L/min) once the outlet temperature stabilized. This data was used to calculate coefficient of heat exchange as follows:

$$Che = (T_{bi} - T_{bo}) / (T_{bi} - T_{wi})$$

where T<sub>bi</sub> = temperature of the blood entering the Monolith module  
 T<sub>bo</sub> = temperature of the blood exiting the Monolith module  
 T<sub>wi</sub> = temperature of the water entering the Monolith heat exchanger

### CLINICAL DATA ACQUISITION

Clinical performance data was collected at the Albany Medical Center, Albany, New York (designated Hospital A), and the Indiana University Medical Center, Indianapolis, Indiana (designated Hospital B). At random intervals throughout the CPB procedure, data sets were recorded. Each data set included the blood flow rate, gas flow rate, FiO<sub>2</sub>, exhaust gas CO<sub>2</sub> content, blood temperature, hematocrit, hemoglobin, and arterial and venous hemoglobin oxygen saturation, pH, pO<sub>2</sub>, pCO<sub>2</sub>, and base excess. During periods of warming from CPB hypothermia, water inlet and blood inlet and outlet temperatures were recorded for coefficient of heat exchange calculations. Additionally, at various blood flow rates during normothermia, inlet and outlet pressures were recorded to calculate blood path pressure drop.

Laboratory data was expressed as mean values with standard deviation from the mean. Clinical heat exchange and pressure drop data were compared using linear regression and analysis of variance of regression coefficients over groups. A p-value of less than 0.05 was considered significant. Clinical and laboratory oxygen transfer data were compared using a computer model (8). This model allows entry of a wide range of venous inlet conditions (pH, pO<sub>2</sub>, pCO<sub>2</sub>, hemoglobin, and temperature) and test parameters (blood flow rate, gas flow rate, and FiO<sub>2</sub>) to predict oxygen transfer and arterial outlet blood conditions.

## RESULTS

### LABORATORY EVALUATION

#### OXYGEN TRANSFER

Oxygen transfer data over the range of test blood flows is shown in Figure 2. As expected, oxygen transfer was greater at higher blood flow rates and FiO<sub>2</sub> values. At the lowest blood flow (2.0 L/min) the oxygen transfer was 144.0±2.7 ml/min, 139±2.2 ml/min, and 130.4±1.7 ml/min at FiO<sub>2</sub> values of 1.0, 0.8, and 0.6

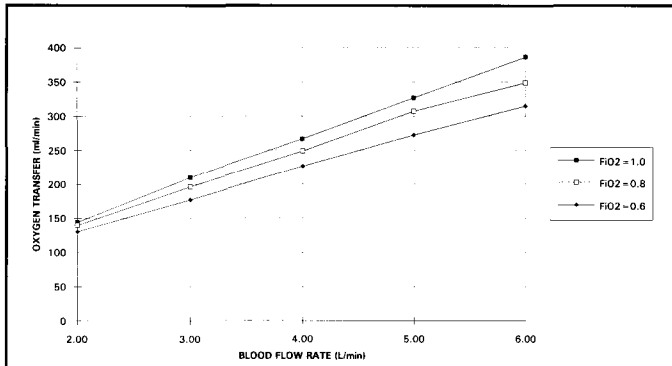

**Figure 2**  
Oxygen transfer data over the range of test blood flow rates and FiO<sub>2</sub> values.

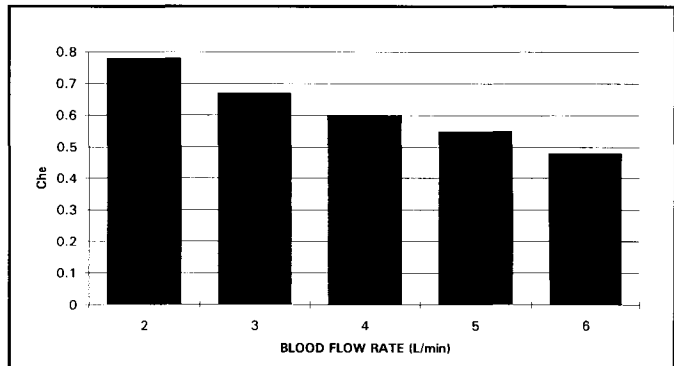

**Figure 4**  
Coefficient of heat exchange (Che) data over the range of test blood flow rates; mean values with standard deviation.

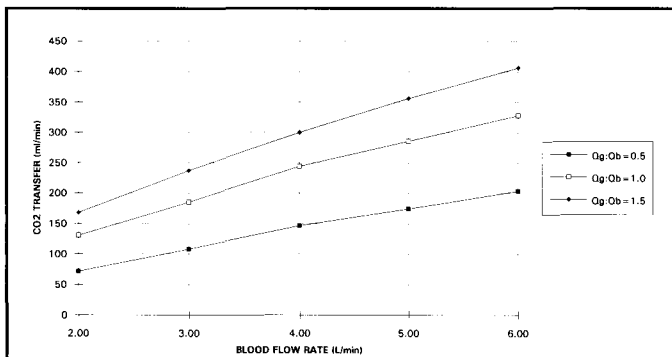

**Figure 3**  
Carbon dioxide transfer data over the range of test blood flow rates and gas to blood flow ratio (Qg:Qb) values.

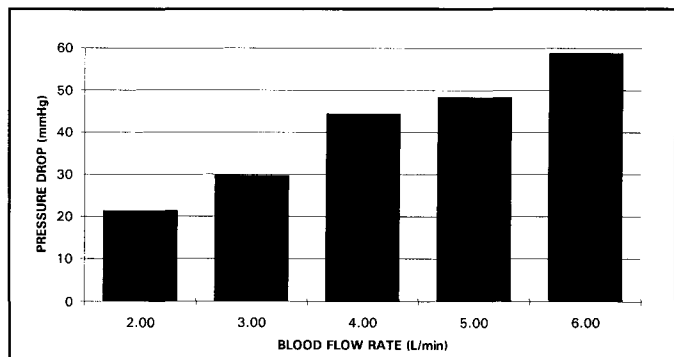

**Figure 5**  
Pressure drop data over the range of test blood flow rates; mean values with standard deviation are shown.

respectively. At the highest blood flow (6.0 L/min) the oxygen transfer was  $386.1 \pm 5.0$  ml/min,  $348.5 \pm 10.6$  ml/min, and  $314.7 \pm 10.1$  ml/min at FiO<sub>2</sub> values of 1.0, 0.8, and 0.6 respectively.

### CARBON DIOXIDE TRANSFER

Carbon dioxide transfer over the range of test blood flows is shown in Figure 3. As expected, carbon dioxide transfer was greater at higher blood flow rates and gas to blood flow ratios (Qg:Qb). At the lowest blood flow (2.0 L/min) the carbon dioxide transfer was  $71.7 \pm 1.9$  ml/min,  $130.7 \pm 2.3$  ml/min, and  $168.6 \pm 8.3$  ml/min at Qg:Qb values of 0.5, 1.0, and 1.5 respectively. At the highest blood flow (6.0 L/min) the carbon dioxide transfer was  $203.5 \pm 3.9$  ml/min,  $328.0 \pm 7.5$  ml/min, and  $406.5 \pm 14.0$  ml/min at Qg:Qb values of 0.5, 1.0, and 1.5 respectively.

### COEFFICIENT OF HEAT EXCHANGE

Coefficient of heat exchange data for the blood flow range studied is depicted in Figure 4. As expected, the coefficient of heat exchange is inversely related to blood flow rate. The actual values are  $0.78 \pm 0.02$ ,  $0.67 \pm 0.03$ ,  $0.59 \pm 0.04$ ,  $0.55 \pm 0.02$ , and  $0.48 \pm 0.02$  for blood flow rates of 2.0, 3.0, 4.0, 5.0, and 6.0 respectively.

### RESISTANCE TO BLOOD FLOW (PRESSURE DROP)

The resistance to blood flow (pressure drop) data over the blood flow range studied is shown in Figure 5. This value was directly related to the blood flow rate. The pressure drop at 2.0 L/min was  $21.4 \pm 2.5$  mmHg and at 6.0 L/min was  $58.8 \pm 16.6$  mmHg. Between these flows the pressure drop was  $29.7 \pm 7.9$  mmHg,  $44.5 \pm 9.8$  mmHg, and  $48.4 \pm 9.7$  mmHg for 3.0, 4.0, and 5.0 L/min respectively.

### CLINICAL DATA AND COMPARISON

#### OXYGEN TRANSFER

A total of 52 sets of data were collected at both hospitals (22 from Hospital A and 30 from Hospital B) which were used to calculate oxygen transfer and carbon dioxide transfer. The blood flow rates ranged from 1.5 to 4.8 L/min, the FiO<sub>2</sub> values from 0.4 to 1.0, and the gas to blood flow ratios from 0.4 to 1.0. Many of these data sets (35 of them) fell outside of our laboratory standard for temperature ( $37 \pm 2^\circ\text{C}$ ) and all of the data sets fell outside of the standard for hemoglobin ( $12 \pm 1$  gm%). The fact that no data set actually fell within the AAMI inlet condition standards made it impossible to directly compare the clinical oxygen and carbon dioxide transfer data with the laboratory data.

In an attempt to resolve this problem, a computer model of oxygenator performance (8) was chosen to compare the laboratory and clinical data. After entering the laboratory data into the model, it was found that oxygen transfer was predicted to within 10% of what was found in the laboratory at all flows (2 to 6 L/min) and  $\text{FiO}_2$  settings (0.60-1.0). Upon entering the clinical data, however, we found that the computer model consistently overpredicted the arterial  $\text{pO}_2$  by as much as 100%.

**RESISTANCE TO BLOOD FLOW (PRESSURE DROP)**

A total of 24 sets of pressure drop data were collected at both hospitals. The blood flow range for this data was 1.8 to 6.0 L/min. All of these were collected within the AAMI standard for temperature ( $37\pm 2^\circ\text{C}$ ) but, again, none met the criteria for hemoglobin content (all were below  $12\pm 1$  gm%). A linear regression model was used to compare the combined hospital data with the laboratory data (Figure 6). The laboratory and hospital data regression equations are described respectively as follows:  $y = 9.47x + 2.22$  ( $r=0.78, p<0.05$ ) and  $y = 8.72x + 9.73$  ( $r=0.50, p<0.05$ ). It was determined through analysis of variance of regression coefficients that there was no significant difference between these two regression equations. We conclude that, in the case of pressure drop, the laboratory data can be predictive of the clinical data.

**COEFFICIENT OF HEAT EXCHANGE**

A total of 94 sets of data were collected to calculate warming coefficient of heat exchange, 41 from Hospital A and 53 from Hospital B. The blood flow rate ranged from 2.0 to 6.0 L/min. A linear regression model was used to compare the data from Hospital A and Hospital B with the laboratory data (Figures 7 and 8). The Hospital A regression equation was  $y = 0.64x - 0.02$  ( $r=0.20, p>0.05$ ). The hospital B regression equation was  $y = 0.77x - 0.04$  ( $r=0.35, p<0.05$ ). Finally, the laboratory regression equation was  $y = 0.91x - 0.07$  ( $r=0.86, p<0.05$ ). Although the data between Hospital B and the laboratory is not significantly different, these results would suggest that there could be difficulties in predicting clinical performance with laboratory data with respect to coefficient of heat exchange.

**DISCUSSION**

As expected, the laboratory evaluation of the Sorin Monolyth was accomplished without difficulty and yielded data which was without great variation. In another recent laboratory evaluation of the Monolyth, Gourlay et al. (2) reported results that, in some cases, were in contrast to ours. In fact, our results tended to show better performance in all categories. For example, in Gourlay's study carbon dioxide transfer at a  $Q_g:Q_b$  of 1.0 and  $Q_b$  of 2.0 and 6.0 L/min was 110 and 195 ml/min respectively (values estimated from graphics). Our results were  $130.7\pm 2.3$  and  $328.0\pm 7.5$  ml/min respectively. Oxygen transfer was reported to be 119 ml/min at 2 L/min ( $\text{FiO}_2 = 1.0$ ) and 408 ml/min at 6 L/min while our data indicated  $144.0\pm 2.7$  and  $386.1\pm 5.0$

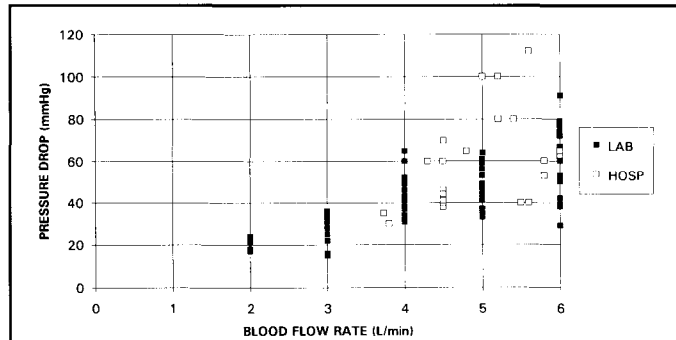

**Figure 6**  
Scatter plot of pressure drop data over the range of test and clinical blood flow rates.

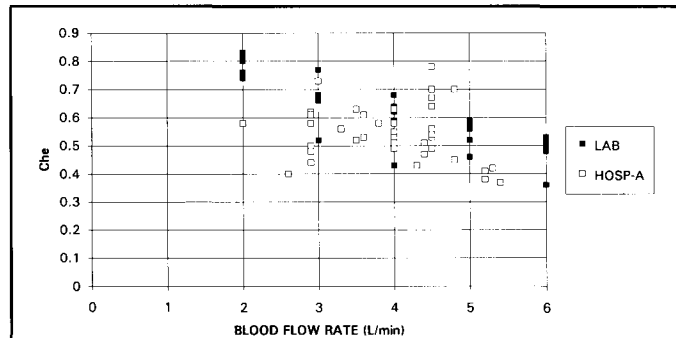

**Figure 7**  
Scatter plot of coefficient of heat exchange (Che) data over the range of test and clinical blood flow rates.

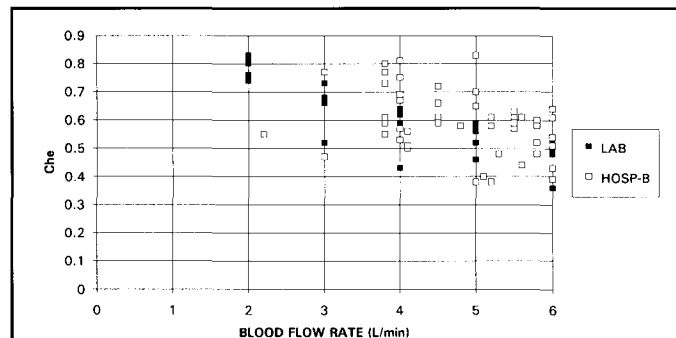

**Figure 8**  
Scatter plot of coefficient of heat exchange (Che) data over the range of test and clinical blood flow rates.

respectively for the same test conditions. Coefficient of heat exchange was reported as 0.58 at 2 L/min (our data =  $0.78\pm 0.02$ ) and 0.43 at 6 L/min (our data =  $0.48\pm 0.02$ ). Pressure drop was estimated from graphics to be 27 mmHg at 2 L/min and 71 mmHg at 6 L/min. In contrast, our data for these same flow rates was  $21.4\pm 2.5$  and  $58.8\pm 16.6$  mmHg respectively. The only variation between studies with respect to venous inlet conditions was a slight difference in hemoglobin concentration ( $12\pm 1$  gm% versus  $13\pm 0.5$  gm%). This contrast of data suggests that, even under strict laboratory conditions, possible variations in the evaluation

protocol make it difficult to compare results.

The wide variations in clinical data with respect to hemoglobin concentration and blood temperature make it extremely difficult to gather sufficient clinical data to compare to the strict stress conditions of laboratory testing. Even with computer modeling of the laboratory data, some questions remain regarding the ability to predict clinical performance. While our linear regression analysis shows some significant predictability with respect to pressure drop and coefficient of heat exchange, interhospital comparisons and at least one hospital/laboratory comparison indicated an inability to directly apply laboratory data to clinical performance.

Much of our investigation suggests an inability to compare data between hospitals. This variance in data is demonstrated in a comparison between a five European center study (documentation supplied by Sorin Biomedical, Irvine, CA) and our combined hospital data.

Data	Sorin Study (avg.)	Our Study
BFR (L/min)	3.5-4.0	4.4±0.93
FiO <sub>2</sub>	0.50-0.65	0.64±0.16
Qg:Qb	0.5-1.0	0.70±0.20
Hgb (gm%)	7-9	7.2±1.4
paO <sub>2</sub> (mmHg)	160-260	254±106

Our study confirms that direct comparison between laboratory and clinical data is difficult, if not impossible, without appropriate computer or statistical modeling. It also indicates that data collected at different clinical sites may not be comparable. Oxygen and carbon dioxide transfer studies are subject to many variables which can differ between laboratories and hospitals. Similarly, a significant difference may be found in pressure drop and coefficient of heat exchange data. Differences in the accuracy or calibration of various pieces of equipment used to perfuse the oxygenator or gather the data may affect the outcome (e.g. blenders, CO<sub>2</sub> analyzers, pumps, blood gas analyzers, pressure monitors). Variations in the equipment used will clearly have an impact. For example, it is likely that the water flow delivered to a heat exchanger at any given temperature varies greatly between devices and institutions. Since the coefficient of heat exchange varies with water flow rate (all else constant), this variability will make comparison of data difficult. Patient variables such as shifts in the oxyhemoglobin dissociation curve, hemoglobin abnormalities, blood viscosity and temperature, and anesthesia or drug interactions will also have an effect. The perfusionist must make allowances for these possibilities when attempting to compare clinical results with other institutions or laboratories.

## ACKNOWLEDGMENTS

The authors would like to acknowledge the Perfusion Staffs at the Albany Medical Center, Albany, NY, and the Indiana University Medical Center, Indianapolis, IN, for their

kind assistance in the acquisition of the clinical data. We would also like to acknowledge Sorin Biomedical, Irvine, CA, for their funding of this project.

## REFERENCES

1. Association for the Advancement of Medical Instrumentation. Standards for blood/gas exchange devices (oxygenators). Draft February 1982 Revision.
2. Gourlay T, Aslam M, Fleming J, Taylor KM. Evaluation of the Sorin Monolyth membrane oxygenator. *Perfusion*. 1990;5:209-219.
3. Vocelka CR, Burdge EC, Kunzelman KS, Thomas R, Verrier ED. An in vitro protocol for evaluation and comparison of membrane oxygenators. *J Extra-Corpor Technol*. 1993;25:161-166.
4. Riley JB, Jallad MS, Winn BA, Hurdle MB. Recommended ventilation technique for the microporous hollow fiber membrane blood oxygenator. *Proc Am Acad Cardiovasc Perf*. 1984;5:101-105.
5. Pearson DT, Clayton R, Murray A, McArdle B. A clinical evaluation of the performance characteristics of six commercially available membrane oxygenators. *Proc Am Acad Cardiovasc Perf*. 1988;9:54-62.
6. Fried DW, Bell-Thomson J. Oxygen transfer efficiency of three microporous polypropylene membrane oxygenators. *Perfusion*. 1991;6:105-114.
7. Nowak J, Pols G, Brands W, Rosseel P. Clinical evaluation of the Bentley Univox membrane oxygenator. *Perfusion*. 1992;7:59-65.
8. Tritt CS. An experimental study and mathematical model of membrane lung performance during low blood flow extracorporeal carbon dioxide removal. Master's Thesis, The Ohio State University, 1986.